

Fuel Tank and Battery Cable Extension Kit

3A1904D

EN

For relocating the fuel tank and battery on Integrated Reactor® and Integrated Reactor® 2 E-30i and E-XP2i. For professional use only.

Not for use in explosive atmospheres.



Important Safety Instructions

Read all warnings and instructions in this manual and the Reactor operation and repair manuals. Save these instructions.

24K333



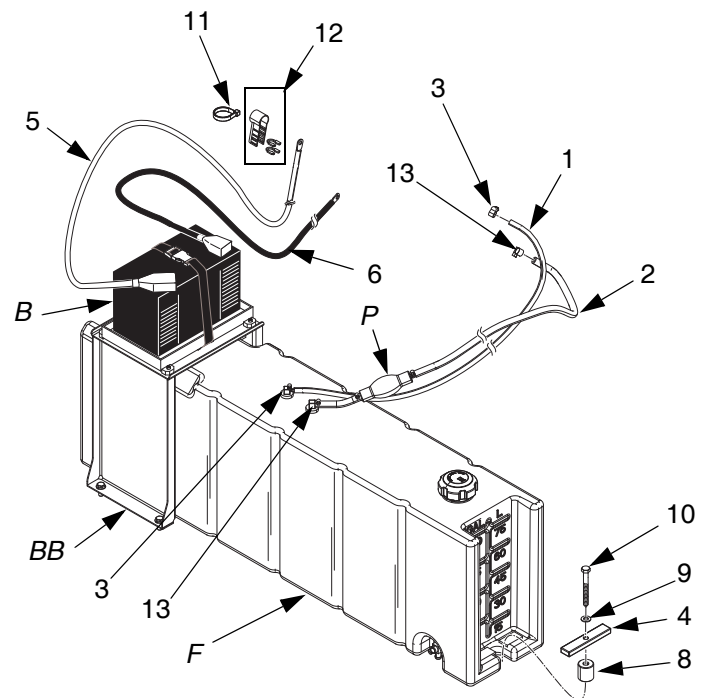

Ref. Part	Description	Qty.
1	16K264 HOSE, fuel, 3/16 in.; 10 ft (3 m)	1
2	16K265 HOSE, fuel, 5/16 in.; 10 ft (3 m)	1
3	125163 CLAMP, hose	2
4	16J889 SUPPORT, fuel tank; includes gasket (4)	2
5	16K234 CABLE, red; 60 in. (1524 mm)	1
6	16K235 CABLE, black; 60 in. (1524 mm)	1
7	--- GASKET	2
8	16K363 SPACER, fuel tank	2
9	100731 WASHER	2
10	404819 SCREW, lag	2
11	125871 TIE, cable, 7.5 in. (190.5 mm)	2
12	126054 INSULATOR, cap	1
13	129875 CLAMP, hose	2



The battery (B), battery bracket (BB), and fuel tank (F) are not included.

ti18609a

Installation

						
<p>Improper battery installation or maintenance may result in electric shock, chemical burns, or explosion. Battery maintenance must only be performed or supervised by personnel knowledgeable of batteries and the required precautions. Keep unauthorized personnel away from batteries.</p>						

1. Perform Shutdown. See Reactor repair manual for instructions.
2. Disconnect battery cables from battery. Remove battery (B) and battery bracket (BB) from pallet.
3. Cut cable tie (11) and remove red insulator cap (12) over the positive stud on the engine starter. Remove the outside nut (N) and short red battery cable. Set nut aside for new longer battery cable. Do not remove fusible link (FL).

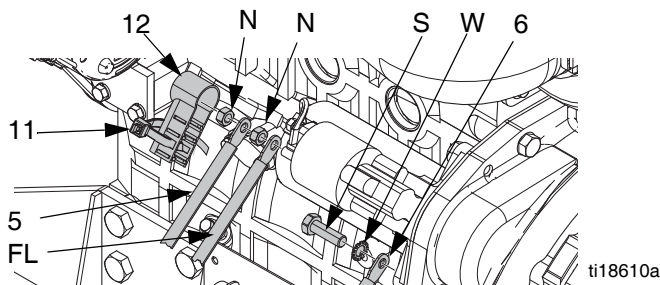

FIG. 1: Battery Cable Connections

4. Remove screw (S) and washer (W) and disconnect the short black battery cable from starter. Set screw and washer aside.
5. Connect the new black battery cable (6) to the starter negative (-). Install washer (W) and screw (S) set aside in step 4.
6. Use the nut (N) set aside in step 3 to secure the new red battery cable (5) to the starter positive (+) stud.
7. Snap the cap insulator (12) over the red battery cable (5). Position the red cap insulator so that the stud is not exposed.

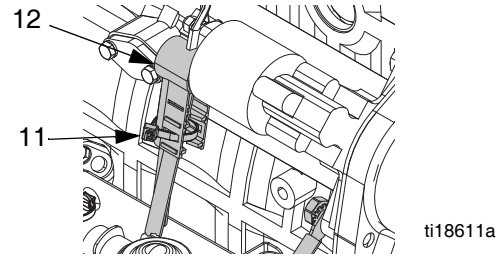

FIG. 2

8. Insert cable tie (11) through cap insulator (12) and tighten to the red battery cable (5). Ensure that the stud is not exposed.
9. Disconnect fuel lines from fuel tank, primer bulb (P), and engine.

NOTE: Keep the fuel lines elevated if the fuel lines are still connected to the tank. This prevents siphoning fuel from tank.

NOTE: Use a cloth or waste container to catch any fuel in short fuel hoses.

10. Remove fuel tank (F) from pallet. See Reactor repair manual for complete instructions.
11. Follow Reactor location and wall installation guidelines in the Reactor operation manual.
12. Ensure fuel tank (F) is mounted level with the engine. Install spacers (8), supports (4), washers (9), and screws (10) on the fuel tank and tighten to floor. See parts illustration.
13. Place hose clamps (3, 13) on fuel hoses (1,2) and connect fuel lines to engine. Ensure the 5/16 fuel supply hose (2) connects to the primer bulb (P).
14. Place battery bracket (BB) over fuel tank. Secure battery bracket to trailer or truck floor with bolts, washers, and nuts (not supplied).
15. Replace and secure battery (B) in battery bracket (BB). Reconnect black cable to negative (-) and red cable to positive (+) battery terminals.

NOTE: Gaskets under the battery bracket (BB) help stabilize the fuel tank during operation.

All written and visual data contained in this document reflects the latest product information available at the time of publication. Graco reserves the right to make changes at any time without notice.

Original instructions. This manual contains English. MM 3A1904

Graco Headquarters: Minneapolis
International Offices: Belgium, China, Japan, Korea

GRACO INC. AND SUBSIDIARIES • P.O. BOX 1441 • MINNEAPOLIS MN 55440-1441 • USA

Copyright 2012, Graco Inc. All Graco manufacturing locations are registered to ISO 9001.

www.graco.com
 Revision D, March 2017